

# BFC Series

## Digital fiber optic amplifier communication converter

### ■ Features

- Sets all Functional performance and parameters from external devices(PL, PLC)
- Supports various communications  
: RS485 communication, Serial Communication, SW input
- Connect up to 32 amplifier units(BF5 Series)
- Slim design with depth 10mm(W10×H30×L70mm)



**⚠ Please read "Caution for your safety" in operation manual before using.**



### ■ User manual

- Visit our web site ([www.autonics.com](http://www.autonics.com)) to download user manual and communication manual.
- User manual describes for specifications and function, and communication manual describes for RS485 communication (Modbus RTU protocol) and parameter address map data.

### ■ Integrated device management program(DAQMaster)

- DAQMaster is a integrated device management program to set parameter and manage monitoring data.
- Visit our website([www.autonics.com](http://www.autonics.com)) to download user manual and integrated device management program.

< Computer specification for using software >

| Item             | Minimum requirements                                       |
|------------------|--|
| System           | IBM PC compatible computer with Intel Pentium III or above |
| Operating system | Microsoft Windows 98/NT/XP/Vista/7                         |
| Memory           | 256MB or more  |
| Hard disk        | More than 1GB of free hard disk space                      |
| VGA              | 1024×768 or higher resolution display                      |
| Others           | RS-232 serial port(9-pin), USB port                        |

< DAQMaster screen >



### ■ Specifications

| Model                  | NPN Solid-state input  |                                    | PNP Solid-state input   |  |
|------------------------|--|------------------------------------|---|--|
|                        | BFC-N  |                                    | BFC-P   |  |
| Power supply*1         | 12-24VDC ±10%  |                                    |   |  |
| Current consumption    | Max. 40mA  |                                    |   |  |
| SW input (SW1, SW2)    | LOW : 0-1V, HIGH : 5-24V<br>SW1/SW2 - HH : Standby, HL : BANK0,<br>LH : BANK1, LL : BANK2  |                                    | SW1/SW2 - LL : Standby, LH : BANK0,<br>HL : BANK1, HH : BANK2 |  |
| Communication function | RS485 communication, serial communication, SW input  |                                    |   |  |
| Communication speed    | 1200, 2400, 4800, 9600, 19200, 38400bps  |                                    |   |  |
| Indication             | <ul style="list-style-type: none"> <li>• Parameter : Red 4digit 7 Segment</li> <li>• Set value : Green 4digit 7 Segment</li> <li>• Indicator : TX indicator(red), RX indicator(green)</li> </ul>   |                                    |   |  |
| Function               | <ul style="list-style-type: none"> <li>• Real-time monitoring (incident light level, on/off state)</li> <li>• Executes every BF5 feature and sets parameter by external device(PC, PLC)</li> </ul> |                                    |   |  |
| Environment            | Ambient temperature  | -10 to 50°C, storage : -20 to 60°C |   |  |
|                        | Ambient humidity   | 35 to 85%RH, storage : 35 to 85%RH |   |  |
| Vibration              | 1.5 mm amplitude or 300m/s <sup>2</sup> at frequency of 10 to 55Hz(for 1 min.) in each of X, Y, Z directions for 2 hours   |                                    |   |  |
| Shock                  | 500m/s <sup>2</sup> (approx. 50G) in each of X, Y, Z directions for 3 times  |                                    |   |  |
| Protection             | IP40(IEC standard)   |                                    |   |  |
| Material               | Case : PBT, Cover : PC   |                                    |   |  |
| Accessory              | Connector type wire(ø4, 3-wire, length: 2m) (AWG 22, Core diameter: 0.08mm, Number of cores: 60, Insulator out diameter: ø1.25mm), Side connector  |                                    |   |  |
| Approval               | <b>CE</b>  |                                    |   |  |
| Unit weight            | Approx. 15g  |                                    |   |  |

\*1 : Powered by supply voltage of the amplifier unit connected by a side connector.

※Environment resistance is rated at no freezing or condensation.

# Communication Converter

## Control output diagram and terminal connections

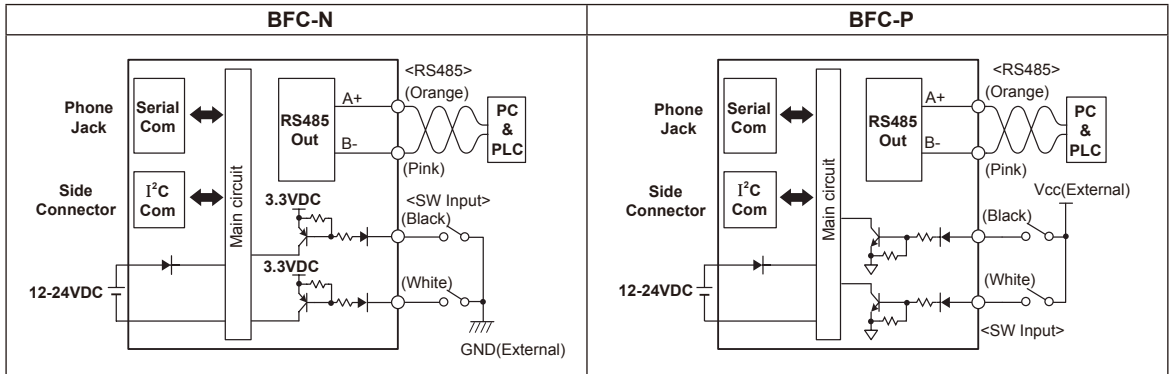

## Dimensions

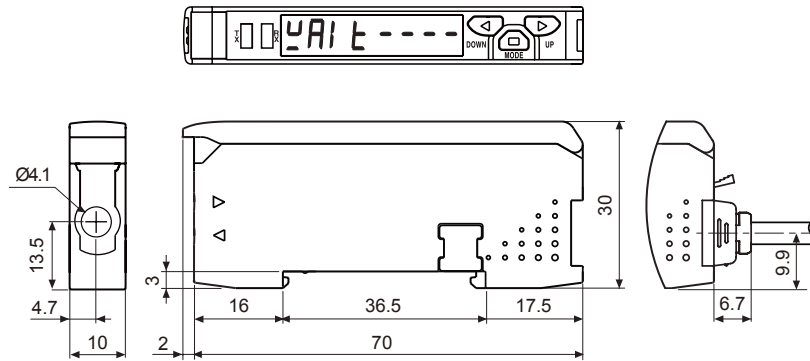

(unit: mm)

### Accessories

- Connector type wire (length: 2m)

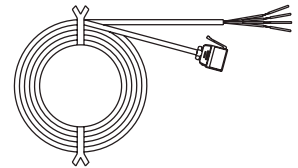

- Side connector



## Installations

### DIN rail installations

- Attachment: Hang up the backside holder on the DIN rail and press the unit toward the DIN rail.
- Detachment: Slide the back part of the unit as the ① figure and lift up the unit as the ② figure.

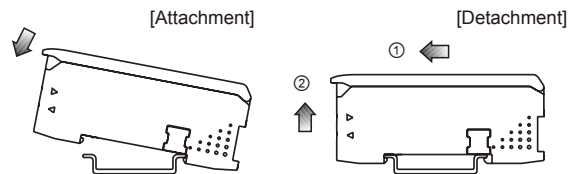

### Communication converter unit (BFC Series) and Amplifier unit (BF5 Series) Connection

- Remove the side cover at the side of communication converter unit where amplifier unit will be connected.
- Attach the side connector to the socket on the side of the communication converter.
- After attaching the communication converter unit and the amplifier unit to the DIN rail, push gently to have both units fastened into each other.

※ Improper connection may cause malfunction.

※ Do not supply the power while connecting or disconnecting.

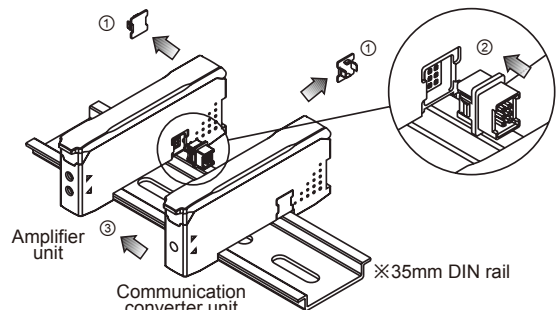

### Connector cable attachment and detachment

- Attachment: Insert the connector cable into the installed communication converter unit on DIN rail until it clicks.
- Detachment: Pull out the connector cable with pressing the connector cable lever downside.

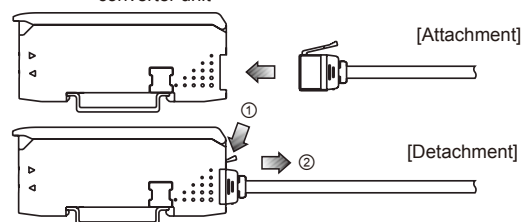

(A) Photo electric sensor

(B) Fiber optic sensor

(C) Door/Area sensor

(D) Proximity sensor

(E) Pressure sensor

(F) Rotary encoder

(G) Connector/Socket

(H) Temp. controller

(I) SSR/ Power controller

(J) Counter

(K) Timer

(L) Panel meter

(M) Tacho/ Speed/ Pulse meter

(N) Display unit

(O) Sensor controller

(P) Switching mode power supply

(Q) Stepper motor & Driver & Controller

(R) Graphic/ Logic panel

(S) Field network device

(T) Software

(U) Other

# BFC Series

## ◎ USB to Serial converter(SCM-US) attachment and detachment

- Connect the USB to Serial converter, SCM-US(sold separately), to PC loader port.

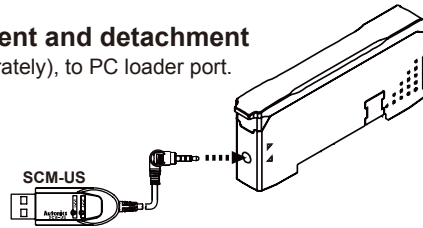

## ■ Communication converter(sold separately)

### • SCM-WF48

(Wi-Fi to RS485,USB wireless communication converter)  
(available soon)



### • SCM-38I

(RS232C to RS485 converter)



### • SCM-US48I

(USB to RS485 converter)



### • SCM-US

(USB to Serial converter)



## ■ Parts description

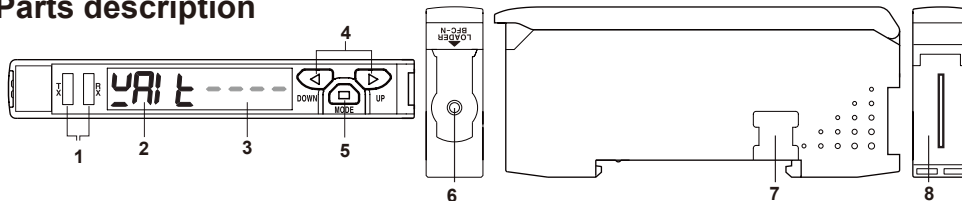

1. TX(Send)-Red LED, RX(Receive)-Green LED: Turns on when communicates and inputs SW.
2. Parameter indication(4digit red 7seg.): Indicates parameter and processes of communication instruction/execution.
3. Set value indication(4digit green 7seg.): Indicates set value and process of communication instruction/execution.
4. UP, DOWN key: To modify set value
5. MODE key: To shift or select parameter when entering parameter setting mode.
6. PC loader port: In case of PC communication, use USB to Serial converter(SCM-US, sold separately).
7. Side cover: To connect an amplifier unit, use a side connector(accessory). Remove a side cover to connect an amplifier unit.
8. Connector cable port : Terminal for attaching a connector cable(accessory) is used for RS485 communication or SW input.

## ■ Communication mode

This communication converter unit supports 2 communication modes and SW input mode.

You can use only 1 mode of 3 modes.

### 1) Serial communication

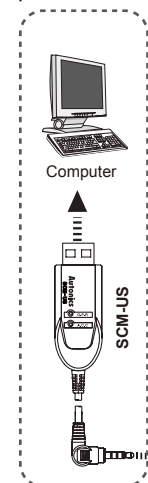

**Caution**  
Do not connect a powered BF5 connector cable to a communication converter unit(BFC). (It may cause damage the product.)

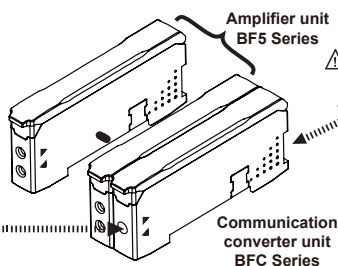

### 2)RS485 communication

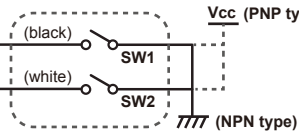
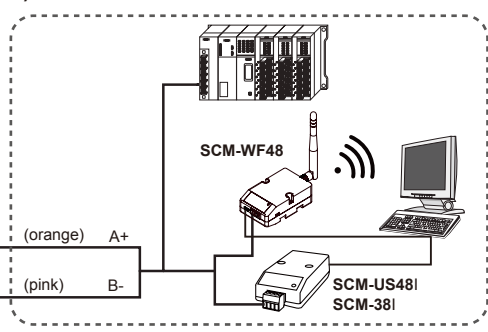

### 1) Serial communication

- ① Connect the USB to Serial converter(SCM-US, sold separately) to the PC loader port for communicating with PC.
- ② It is very easy to manage parameters and monitor data of connected amplifier units(BF5 Series) using the integrated management program DAQMaster(free).

# Communication Converter

## 2) RS485 communication

- PLC connection: ① Connect directly to a PLC using RS485 communication cable of the communication converter unit.  
② Amplifier units(BF5 Series) can be controlled through PLC.
- PC connection: ① Connect PC using Communication converter(SCM-381, SCM-US481, SCM-WF48 sold separately).  
② It is very easy to manage parameters and monitor data of connected amplifier units(BF5 Series) using the integrated device management program DAQMaster(free).

※Following is a screen of DAQMaster properties window of a computer connected communication converter unit.

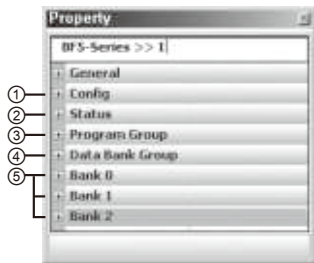

### ① Config

Indicates the number of amplifier units connected to the communication converter unit(BFC).

### ② Status

Indicates the information of the selected amplifier unit(Dual, Single) by channel, connected to communication converter unit(BFC).

### ③ Program group

Set values of the amplifier unit can be changed. When set values of the amplifier unit changed, TX(Red) and RX(Green) LEDs on communication converter unit will flash indicating application of set values to the amplifier unit.

### ④ Data Bank Group

Data bank and group teaching features of amplifier unit can be set. Amplifier unit can be initialized as well.

※Indications appear on communication converter and amplifier units depending on applied instruction are shown below.

### Communication waiting state

This indicates the waiting state for instructions while preserving master unit(PC,PLC) and communication converter unit real time data transfer(incident light level of the amplifier unit).

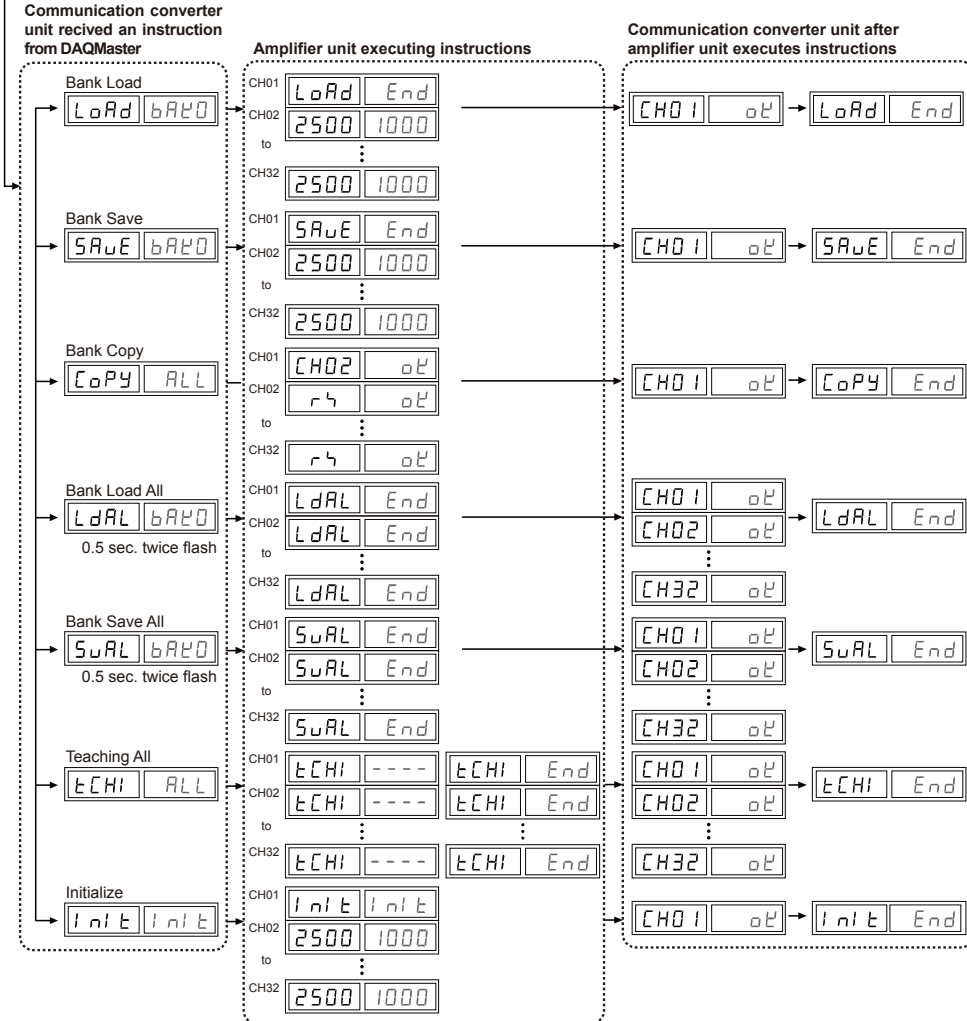

⑥ **Data Bank** : Set value of data bank(Bank 0, Bank 1, Bank 2) can be saved.

- (A) Photo electric sensor
- (B) Fiber optic sensor
- (C) Door/Area sensor
- (D) Proximity sensor
- (E) Pressure sensor
- (F) Rotary encoder
- (G) Connector/Socket
- (H) Temp. controller
- (I) SSR/ Power controller
- (J) Counter
- (K) Timer
- (L) Panel meter
- (M) Tacho/ Speed/ Pulse meter
- (N) Display unit
- (O) Sensor controller
- (P) Switching mode power supply
- (Q) Stepper motor& Driver&Controller
- (R) Graphic/ Logic panel
- (S) Field network device
- (T) Software
- (U) Other

# BFC Series

## 3)SW input

SW input is a feature which allows amplifier unit connected with the communication converter unit to load all banks.

Applying signals to SW1(Black) and SW2(White) of the connector cables which is connected to the communication converter unit allows change of banks as shown in chart 1.(SW input signal duration should be longer than 3 seconds.)

[Chart 1] Bank selection table based on SW input

|   | Bank                           | NPN |     | PNP |     |
|---|--------------------------------|-----|-----|-----|-----|
|   |                                | SW1 | SW2 | SW1 | SW2 |
| 1 | Standby signal(Using set Bank) | H   | H   | L   | L   |
| 2 | Bank 0                         | H   | L   | L   | H   |
| 3 | Bank 1                         | L   | H   | H   | L   |
| 4 | Bank 2                         | L   | L   | H   | H   |

※Indications appear on communication converter and amplifier units depending on applied instruction are shown below.

### SW input standby state

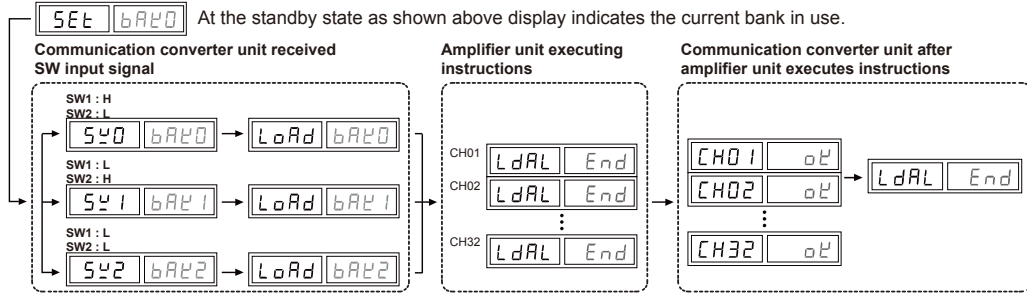

### < Communication specification >

| Standard                         | EIA RS485                               | Standard             | EIA RS485       |
|----------------------------------|---|----------------------|-----------------|
| Maximum connections              | 31(Address setting: 01 to 99)           | Response wating time | 20 to 99ms      |
| Communication method             | 2-wire half duplex                      | Start bit            | 1bit(Fixed)     |
| Synchronization method           | Asynchronous                            | Stop bit             | 1bit, 2bit      |
| Effective communication distance | Max. 800m                               | Parity bit           | None, Even, Odd |
| Communication speed              | 1200, 2400, 4800, 9600, 19200, 38400bps | Data bit             | 8bit(Fixed)     |
|                                  |   | Protocol             | Modbus RTU      |

※It is not allowed to set overlapping communication address at the same communication line.

※Please use a proper twist pair for RS485 communication.

## Parameter setting

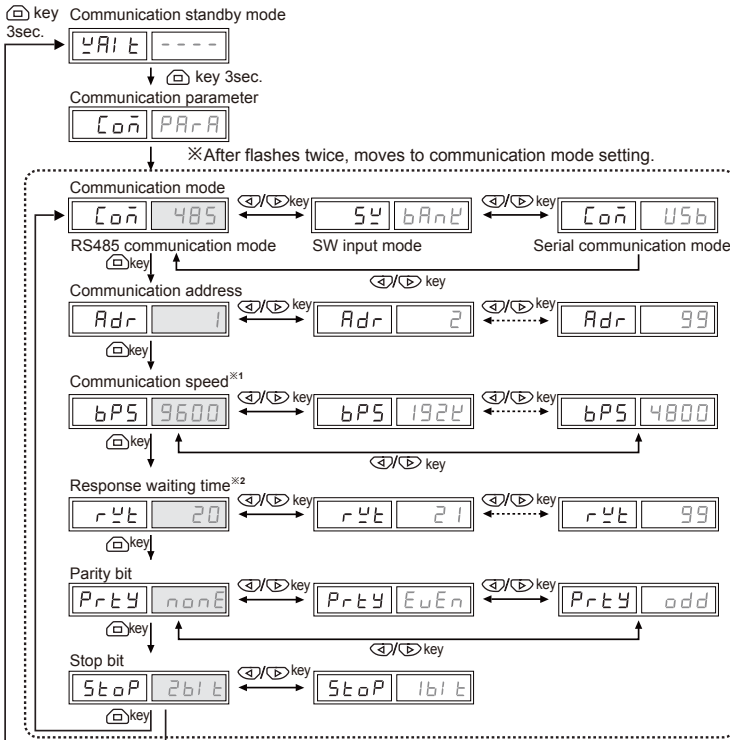

※1:

| Communication speed display |         |
|-----------------------------|---------|
| Speed                       | Display |
| 1200                        | 1200    |
| 2400                        | 2400    |
| 4800                        | 4800    |
| 9600                        | 9600    |
| 19200                       | 1920    |
| 38400                       | 3840    |

※2: Communication response waiting time range is 20 to 99ms.(Depending on the number of amplifier units connected, response time may increase up to 350ms.)

※ : Factory default

# Communication Converter

## ■ Error code

| Error code | Cause   | Troubleshooting  |
|------------|---|--|
| $E_{rA}$   | Reading/Writing errors occur while processing data in EEPROM of amplifier unit.   | Check the circuitry around EEPROM inside the product.  |
| $E_{rb}$   | <ul style="list-style-type: none"> <li>Slave fails to execute Master's group instructions such as Copy/Load/Save/Teaching sent through communication line due to unstable communication line.</li> <li>Other communication problems.</li> </ul> | <ul style="list-style-type: none"> <li>Check the connection status between communication unit and amplifier units.</li> <li>Check the circuitry around the side connector and hardware condition.</li> </ul> |

### Solution methods for communication problems

#### 1) Communication errors during Serial or RS485 connections

- Check if the communication mode selected in communication converter unit suits installation environment.
- Check and equalize the address of communication converter unit and address set in DAQMaster.
- Check and equalize the communication port of communication converter unit and the communication port number set in DAQMaster.

#### 2) Communication errors during SW signal input

- Check if the communication mode set in communication converter unit is SW input mode(SW Bank).
- Check if the connections are made thoroughly depending on NPN or PNP input type.

(A)  
Photo  
electric  
sensor

(B)  
Fiber  
optic  
sensor

(C)  
Door/Area  
sensor

(D)  
Proximity  
sensor

(E)  
Pressure  
sensor

(F)  
Rotary  
encoder

(G)  
Connector/  
Socket

(H)  
Temp.  
controller

(I)  
SSR/  
Power  
controller

(J)  
Counter

(K)  
Timer

(L)  
Panel  
meter

(M)  
Tacho/  
Speed/  
Pulse  
meter

(N)  
Display  
unit

(O)  
Sensor  
controller

(P)  
Switching  
mode power  
supply

(Q)  
Stepper  
motor&  
Driver&Controller

(R)  
Graphic/  
Logic  
panel

(S)  
Field  
network  
device

(T)  
Software

(U)  
Other